

**EBAC MODEL PD150  
INDUSTRIAL DEHUMIDIFIER  
OWNER'S MANUAL**



Ebac Industrial Products, Inc.  
700 Thimble Shoals Blvd, Suite 109  
Newport News, VA. 23606-2575  
Tel: (757) 873 6800 Fax: (757) 873 3632  
Website [www.ebacusa.com](http://www.ebacusa.com)

## PD150

### PACKAGE CONTENTS

Item	Description	Quantity
10150GY-US	Dehumidifier	1
3014338	PVC tube – 12mm I/D	3M
3086101	Jubilee clip	1
3037866	6 Pin Plug	1
TPC607	Manual	1

## UNPACKING

Carefully remove the PD150 dehumidifier unit from its transit box and visually check for signs of transit damage. If there is evidence of damage DO NOT attempt to operate the unit, call your supplier for advice. Do not discard the packing, it will be useful when transporting the dehumidifier unit in the future.

## INTRODUCTION

The Ebac PD150 industrial dehumidifier removes moisture from the air through the refrigeration process.

The Ebac PD150 is basically comprised of:

- 1) A compressor
- 2) A refrigerant evaporator coil
- 3) A refrigerant condenser coil
- 4) One circulation fan
- 5) A humidistat
- 6) A cabinet to house the above components

The fan draws the moist air through the cold evaporator coil which cools the air below its dew point. Moisture forms on the evaporator coil and is collected in the condensate tray which is equipped with a permanent drain. The cooled air then passes through the hot condenser coil where it is reheated using the same energy removed during the cooling phase, plus the additional heat generated by the compressor. The air is therefore discharged from the dehumidifier at a slightly higher temperature with a lower absolute humidity than with which it entered. Continuous circulation of air through the dehumidifier gradually reduces the relative humidity within the area.

The dehumidifier is a rugged, reliable drying unit designed to operate effectively over a broad range of temperature and humidity conditions.

The dehumidifier uses an internally mounted adjustable humidistat to enable you to select the level of dryness.

The unit can also be used with an external humidistat or the EIPL touch display panel (via the 6 pin connector) to control the level of dryness.

## SPECIFICATIONS

<b>MODEL:</b>	Ebac PD150
<b>HEIGHT:</b>	17.5" (443mm)
<b>WIDTH:</b>	27.5" (700mm)
<b>DEPTH:</b>	26" (660mm)
<b>WEIGHT:</b>	144 lbs (65Kg)
<b>AIRFLOW:</b>	585 CFM (995 M3/hr)
<b>POWER:</b>	1.9 KW
<b>POWER SUPPLY:</b>	220V / 60Hz / 1ph
<b>FINISH:</b>	Powder-coated Epoxy
<b>REFRIGERANT TYPE/QTY:</b>	R410a / 42.3oz (1.2Kg)

## INSTALLATION

### POSITIONING:

Position the dehumidifier unit in the center of the room to be conditioned if at all possible. However, if a damp patch is particularly apparent the outlet grille should be pointed towards it if possible.

This unit can also be used in a duct system where applicable, please see the diagrams on the following pages which identify the overall sizes of the unit and also the mounting points.

Connect the drainage outlet to a suitably sized hose and run the hose to a permanent drain.

Connect the unit power cable to a grounded power source.

### NOTE:

Both inlet grille and outlet grille of the dehumidifier unit must have clear space around them and not be obstructed in anyway. For correct installation and operation, the unit inlet and outlet must have a clearance of 0.5M from all adjacent surfaces and or structures.

### Optional Control Methods

#### 1. External Humidistat

- Connections for an external humidistat are available on the 6 pin connector above the main isolator using the plug supplied.
- The remote humidistat should have a normally open set of contacts which close on humidity rise.
- This connection is low voltage low current, suggested cable specification 2 core 16/0.2 (0.5mm) screened cable.
- In order to enable the external humidistat, the jumper pin on the main control PCB needs to be removed. This is located behind the controls cover.

Ensure the unit is disconnected from the electrical supply prior to removing any covers.

Simply locate the main control PCB and pull of the blue jumper from Pin E.

The external humidistat should be connected across pins 5 & 6 of the connector as shown below

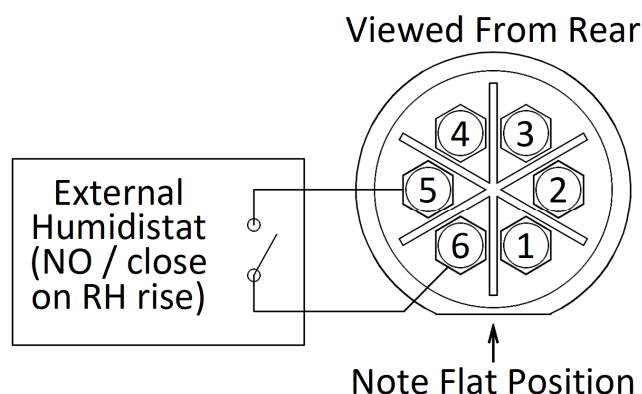



## 2. EIPL Touch Display Panel

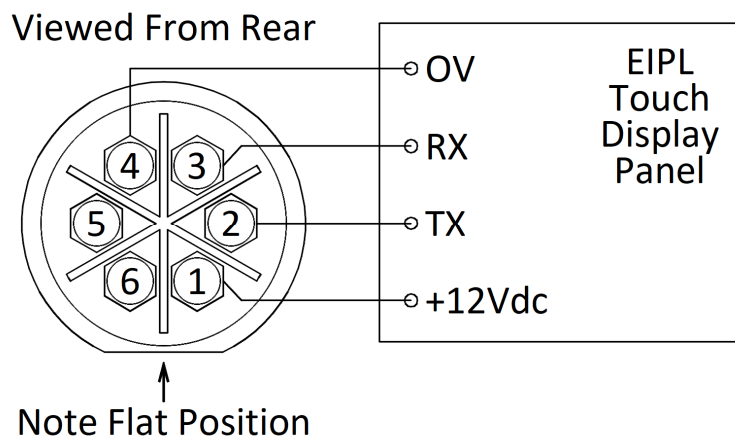

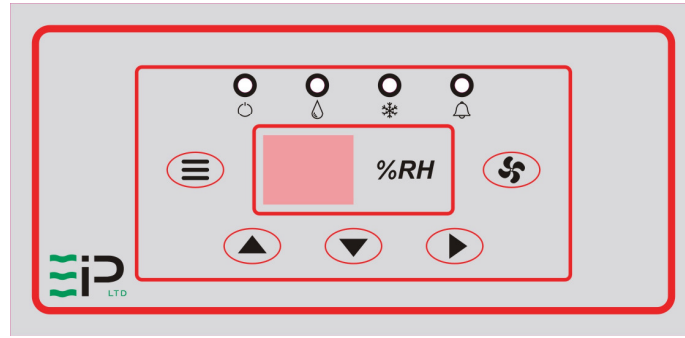

- RS232 connections for the EIPL touch display panel are available on the 6 pin connector above the main isolator.
- Suggested cable specification 4 core 16/0.2 (0.5mm) screened cable.
- Connection details:-
  - Free Socket - Pin 1 - +12Vdc
  - Free Socket - Pin 2 - TX
  - Free Socket - Pin 3 - RX
  - Free Socket - Pin 4 - 0V

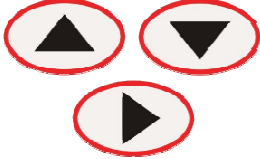

## OPERATION



Button / Legend	Function	Description
	Menu	Cycle through menu options and adjust the desired set point. See below for list of menu options
	Recirculation	Select recirculation fan or dehumidification mode
	Navigation	Adjust the humidity set point UP/DOWN and enter to confirm

Indicator	Function	Description
	ON/OFF	Green – On
	Drying / Recirculation	Blue – Flashing – Drying Required Blue – Solid – Drying On Green – Solid – Recirculation Mode (Fan Only)
	Defrost	Yellow – Flashing – Defrost mode selected Yellow – Solid – Defrosting in progress
	Alarm	Red – Solid – Fault - High RH Indicating the RH is 10% higher than the set point NOTE: This function is not available if an external humidistat is used. The alarm indicator may remain ON.

## Menu Options

Pressing the Menu button cycles through the following pages of information.

Menu Options when dehumidifying mode is selected

Menu	Display	Information
1	Set RH	Using the Up / Down Keys adjust the humidity to the desired set-point, pressing the Enter key to accept and save.
2	Temperature	Indicates the current room temperature.
3	Coil Temp	Shows the current coil temperature. (< -9degC display “—“)
4	Time To Start	Displays the time to start drying (mins) or “on” if already drying
5	Time To Defrost	If defrost mode is selected, this option shows the remaining time until defrost will occur. The yellow defrost light will be flashing indicating a defrost is required.
6	Time In Defrost	If defrost is currently occurring, the yellow defrost light will be solid, and the display will show the time remaining before defrost ends. Defrost not required or active the display will show “—“
Notes on Time values above 2 digits no decimal point indicates a time > 10mins 2 digits with a decimal point indicates mins and tenths of a min, ie 8.5 = 8mins 30 secs		

Menu Options when recirculation mode is selected

Menu	Display	Information
1	Humidity	Indicates the current room Humidity.

## Operation

Plug the unit into a suitable wall socket and power on.

Set the Yellow/Red isolator switch to ON.

Note the Power On Indicator shows Solid Green.

To prevent the compressor starting too quickly after being powered down, there is an inbuilt compressor off timer. This delayed start prevents the compressor from restarting for 6 minutes after being switched off. Note this feature is reset when the isolator is set to OFF or power is removed from the unit.

The dehumidifier remembers the last mode of operation, and also the previously adjusted set point.

Once the dehumidifier is started, the drying / recirculation light will indicate the selected mode or operation.

Adjust the mode, as required. (Recirculation or Drying).

In drying mode, the display will show the room humidity level.

In recirculation mode the display shows the current room temperature.

Using the Menu Key cycle through the menu options to the Set RH page, using the up/down and enter keys adjust the humidity to the desired level.

The dehumidifier will now self-regulate to maintain the desired humidity level. The unit will automatically defrost as needed. In warmer climates defrost is not required, allowing the dehumidifier to continually dry.

**If, after carrying out the above procedures, the appliance does not appear to function properly, refer to the *Trouble Shooting* section, which follows, or contact EIPL.**

## ROUTINE SERVICE

**WARNING:** ENSURE THAT THE POWER CORD TO THE MACHINE HAS BEEN DISCONNECTED BEFORE CARRYING OUT ROUTINE SERVICE. THE SERVICING AND REPAIR OF THIS UNIT SHOULD ONLY BE CARRIED OUT BY A SUITABLY QUALIFIED PERSON.

To ensure continued full efficiency of the dehumidifier, maintenance procedures should be performed as follows:

1. Clean the surface of the evaporator and condenser coils by blowing the dirt out from behind the fins with compressed air. Hold the nozzle of the air hose away from the coil (approx 6") to avoid damaging the fins. Alternatively, vacuum clean the coils.

**WARNING:** DO NOT STEAM CLEAN REFRIGERATION COILS.

2. Check that the fan is firmly secured to the motor shaft and that the fan rotates freely. **The fan motor is sealed for life and therefore does not need oiling.**
3. To check the refrigerant charge, run the unit for 15 minutes and briefly remove the cover. The evaporator coil should be evenly frost coated across its surface. At temperatures above 70°F, the coil may be covered with droplets of water rather than frost. Partial frosting accompanied by frosting of the thin capillary tubes, indicates loss of refrigerant gas or low charge.
4. Check all wiring connections.

**IF ANY OF THE PRECEDING PROBLEMS OCCUR, CONTACT THE EBAC SERVICE CENTER PRIOR TO CONTINUED OPERATION OF THE UNIT TO PREVENT PERMANENT DAMAGE.**

## REPAIRS

1. Should an electrical component fail, consult the Factory Service Center to obtain the proper replacement part.
2. If refrigerant gas is lost from the machine, it will be necessary to use a refrigeration technician to correct the fault. Contact the Factory Service Center prior to initiating this action.

Any competent refrigeration technician will be able to service the equipment. The following procedure must be used:

- a. The source of the leak must be determined and corrected.
- b. The machine should be thoroughly evacuated before recharging.
- c. The unit must be recharged with refrigerant measured accurately by weight.
- d. For evacuation and recharging of the machine, use the crimped and brazed charging stub attached to the side of the refrigerant compressor.

The charging stub should be crimped and rebrazed after servicing. **NEVER** allow permanent service valves to be fitted to any part of the circuit. Service valves may leak causing further loss of refrigerant gas.

3. The refrigerant compressor fitted to the dehumidifier is a durable unit that should give many years of service. Compressor failure can result from the machine losing its refrigerant gas. The compressor can be replaced by a competent refrigeration technician.

Failure of the compressor can be confirmed by the following procedure:

- a. Establish that power is present at the compressor terminals using a voltmeter.
- b. With the power disconnected, check the continuity of the internal winding by using meter across the compressor terminals. An open circuit indicates that the compressor should be replaced.
- c. Check that the compressor is not grounded by establishing that a circuit does not exist between the compressor terminals and the shell of the compressor.

## TROUBLESHOOTING

<u>SYMPTOM</u>	<u>CAUSE</u>	<u>REMEDY</u>
<b>Unit inoperative</b>	1. no power to unit	1. Check the power from the power supply panel
<b>Little or no airflow</b>	1. Loose fan on shaft 2. Fan motor burnt out 3. Dirty refrigeration coils 4. Loose electrical wiring	1. Tighten fan 2. Replace the fan motor 3. See <i>Routine Maintenance</i> Section 4. Check the wiring diagram to find fault and repair
<b>Little or no water extraction</b>	1. Insufficient air flow 2. Compressor fault 3. Loss of refrigerant gas	1. Check all of the above 2. Contact the Factory Service Center 3. Contact the Factory Service Center
<b>Unit vibrates excessively</b>	1. Loose compressor mounts 2. Damaged fan	1. Tighten the nuts on the compressor mounts 2. Replace fan
<b>Water flooding inside the machine</b>	1. Drain pipe blocked/frozen 2. Drain pipe too high	1. Clear the obstruction 2. Ensure that no section of the drain hose is above the level of the water outlet

Ebac Industrial Products, Inc.  
 700 Thimble Shoals Blvd, Suite 109  
 Newport News, VA. 23606-2575  
 Tel: (757) 873 6800 Fax: (757) 873 3632  
 Website [www.ebacusa.com](http://www.ebacusa.com)

### SPARE PARTS LIST

Description	Part Number
Product Part Number	10150GY-US
Controls Display PCB	1619536
Humidity Sensor PCB	1619526
PCB Timer	1619531
PCB connecting cable (700mm)	2013748
Evaporator Coil	2015024
Condenser Coil	2015025
Filter	2015028
Keypad Label	2015031
Coil Bracket Blanking Foam	2018724
Sponge Seal 16mm x 22mm	3015106
Capillary Tube	3014249
10mm ID insul tube	3014301
Reversing Valve	3020834
Filter Dryer	3020957
Pressure Stat	3021154
Solenoid Coil	3030454
Mains Cable	3031202
Terminal Block	3031403
25mm Open Grommet	3032111
M16 Cable Gland	3032511
M16 Gland Nut	3032512
Coil Sensor	3035142
Humidity Sensor Housing	3035164
6 Pin Socket	3037865
6 Pin Plug	3037866
Fan Wheel	3040247
Fan Inlet Ring	3040248
Jubilee Clip	3086101
PCB Mounting Pin	3101413
Contactator	3930736
Isolator	3932332
Light Pipe Lens	3931732
Compressor Capacitor	3933511
Mains Plug	3934516
PCB Connecting Cable (300mm)	3934519
PCB – Plug Cable	3935428
Condensate Drain Tube	3944115
Compressor	3944948
Fan Motor	3947037

## WARNINGS

This appliance can be used by children from 8 years and above and persons with reduced physical, sensory or mental capabilities or lack of experience and knowledge if they have been given supervision or instruction concerning use of the application in a safe way and understand the hazards involved.

Children shall not play with the appliance.

Cleaning and user maintenance shall not be made by children without supervision.

If the SUPPLY CORD is damaged, it must be replaced by the manufacturer, its service agent or similarly qualified person in order to avoid hazard.

This product contains fluorinated greenhouse gases covered by the Kyoto Protocol. The refrigeration system is hermetically sealed.

The Global Warming Potential (GWP) of refrigerants used in products manufactured by Ebac Industrial Products Ltd is as follows

R410a – 2088

For type and weight of refrigerant contained in this unit, please refer to the product data label

Due to the high pressures within the refrigeration circuit, under no circumstances must direct heat be applied to the evaporator coil in an attempt to remove the build-up of ice.

No attempt should be made to cut open any part of the refrigeration circuit due to high pressures and gas involved.

If the unit is switched off at the mains power supply for any reason, the unit must be allowed to stand at rest for at least three minutes before restarting.



Drawing No.	:- TPC607
Issue	:- 3
Date	:- 18/03/26



Drawing No.	:- TPC607
Issue	:- 3
Date	:- 18/03/26

### **UK Head Office**

Ebac Industrial Products Ltd  
St Helens Trading Estate  
Bishop Auckland  
County Durham  
DL14 9AD

Tel: +44 (0) 1388 664400  
Fax: +44 (0) 1388 662590

[www.eipl.co.uk](http://www.eipl.co.uk)  
[sales@eipl.co.uk](mailto:sales@eipl.co.uk)

### **American Sales Office**

Ebac Industrial Products Inc  
700 Thimble Shoals Blvd.  
Suite 109, Newport News  
Virginia, 23606-2575  
USA

Tel: +01 757 873 6800  
Fax: +01 757 873 3632

[www.ebacusa.com](http://www.ebacusa.com)  
[sales@ebacusa.com](mailto:sales@ebacusa.com)